

# MICRO-ASSEMBLY AND SYSTEM INTEGRATION

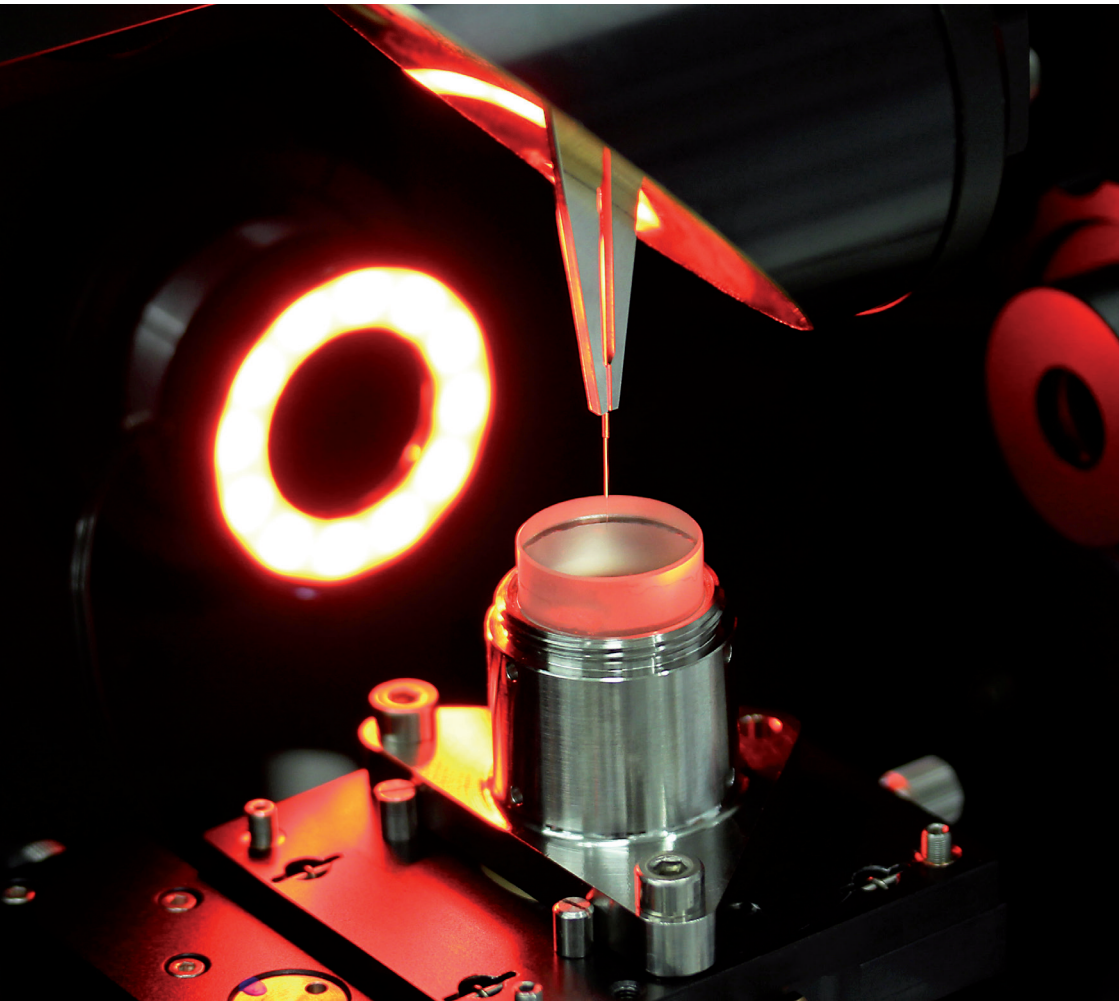

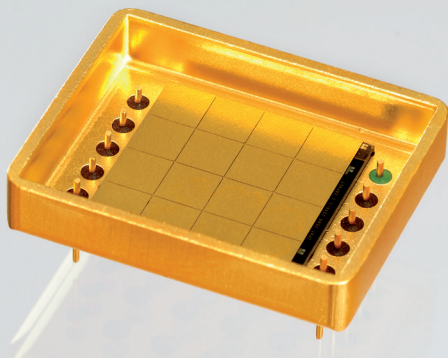



## SOLUTIONS WITH LIGHT EXPERTISE IN OPTICAL SYSTEM TECHNOLOGY

The Fraunhofer Institute for Applied Optics and Precision Engineering IOF in Jena develops innovative optical systems to control light from its generation and manipulation to its use.

Our mission is to cover the entire process chain from opto-mechanical and opto-electrical system design to the manufacturing of customized prototypes. Outstanding basic research results and strategic cooperation arrangements with various partners in the industry demonstrate the research strengths of the Fraunhofer IOF.

The Fraunhofer IOF has a regional focus and maintains diverse cooperation arrangements with both businesses as well as research and educational institutions at its location. As a scientific center in the Jena optics region, it

contributes to regional development with innovation, staff and knowledge transfer, and spin-off ventures. At the same time, the Fraunhofer IOF is both national and international in its orientation and has a network of partners in Germany, Europe, North America and Asia.

The Institute works in the five research fields: Optical Components and Systems, Precision Engineering Components and Systems, Functional Surfaces and Layers, Photonic Sensors and Measuring Systems and Laser Technology. The close links between them make it possible to develop system solutions for customers.

Our technology field of Micro-Assembly and System Integration is presented in the following pages.

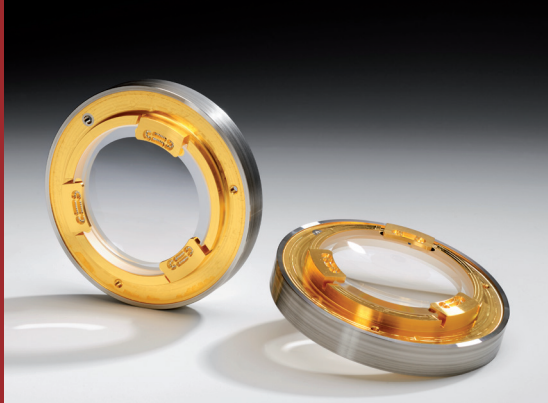
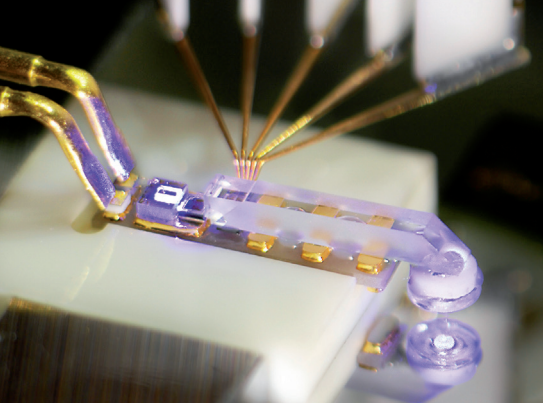

## MICRO-ASSEMBLY AND SYSTEM INTEGRATION

The Institute has extensive expertise in the development of technologies for the hybrid integration of various components with high precision for the construction of complex opto-mechanical and opto-electronical micro- and macro-systems.

This encompasses all assembly sub-processes from cleaning and preparation of components, handling, positioning and aligning to the joining and system integration technologies: adhesive bonding, laser-based soldering, inter-layer free bonding, laser-based splicing, and mechanical clamping.

Micro-assembly techniques and lithography-based wafer-level processes offer new approaches to cost-effective and hybrid system integration. We offer integration based on multifunctional

system platforms that provide stable bases for the mounting of complex optical components. Our in-house ultra-precision production technologies support the system integration with high quality machined surfaces. Coating processes at Fraunhofer IOF provide optical multi-layer systems and functionalize surfaces for bonding processes.

The competence of Fraunhofer IOF covers the complete process chain from design and simulation to the prototype of the photonic system. Our assembly and integration techniques address optical systems for harsh environmental and vacuum conditions in aero-space applications. The performance of components and assembled systems is characterized for various load cases by comprehensive optical and mechanical measurement equipment.

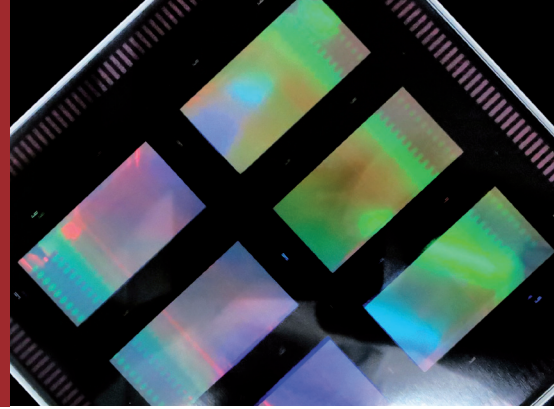

## PROJECTS AND APPLICATIONS

At Fraunhofer IOF, integration approaches are developed in close cooperation with customers and partners for spaceborne missions, applications for vacuum, and high-power systems:

- **ESA / Sentinel 2** – Integration of VNIR/SWIR Filter Arrays for a satellite based earth observation instrument
- **ESA / AIDA** – Adhesive bonding of sensor arrays to chip carrier for space debris detection
- **DLR / LensMount** – Lenses, low strain soldered to mounts and adjustment turned, for objectives in short-wave and high-power applications
- **EFRE / PARCEL** – Sub-micron adjustment and vacuum compatible joining of micro-structured components for Multi Shaped Beam Lithography
- **BMBF / VORTEIL** – Wafer-level integration of micro-lenses for VCSEL based laser systems
- **BMBF / PriamoS** – Innovative lighting and display applications using wafer-level integrated micro-optical arrays
- **F-K-Splice** – Fiber-Collimator Splice with housing for Grace FO Laser Ranging Instrument
- **DLR / SmartSplice** – CO<sub>2</sub>-laser based splice/taper equipment
- **Waveguide image-slicer for PEPSI** (Potsdam Echell Polarimetric and Spectroscopic Instrument) – Automated alignment and index matched adhesive bonding
- **DLR / BOTEC** – Bonding Technologies for Optical Subsystems in Satellite Communications
- **EU / LIFT** – Leadership In Fibre Laser Technology, fabrication of Faraday isolator elements by direct bonding for use at high laser output power

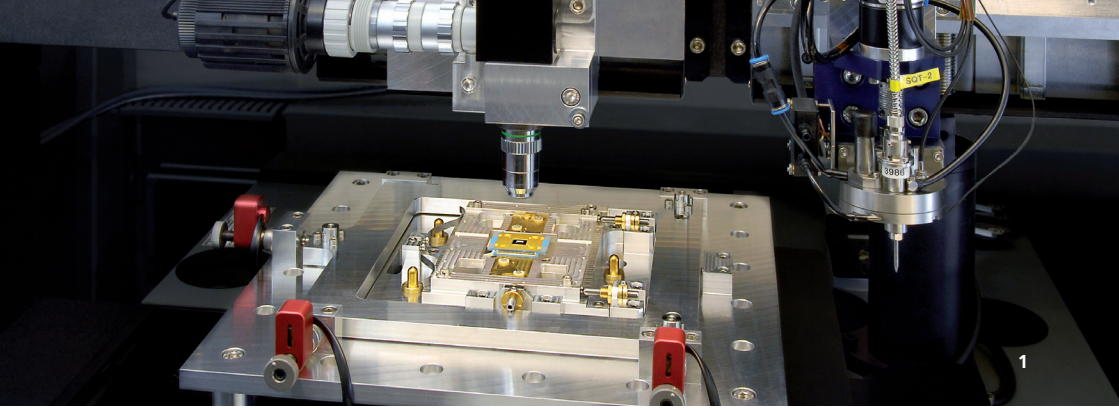

## POSITIONING AND ADJUSTMENT

The positioning of optical parts is an important step during the integration of optical systems. Alignment steps of 50 to 100 nm are required to reach sub-micron accuracies. A bidirectional positioning accuracy of 0.5  $\mu\text{m}$  is a typical requirement of the assembly and alignment processes. The positioning devices used at IOF are mechanically isolated and temperature stabilized to guarantee reproducible and long term stable alignment.

*1 Precision gantry system with assembly stage.*

- Air bearing positioning system with 300 mm  $\times$  300 mm travel range, bidirectional reproducibility of the position of 0.3  $\mu\text{m}$
- Piezo driven actuators with 30 nm step width
- 6-degree of freedom manipulators
- Integration of different positioning systems into graphical user interfaces
- Automated alignment processes using image processing
- Development of specialized devices for handling and joining procedures

---

**Contact | Matthias Mohaupt**

Phone: +49 3641 807 342 | [matthias.mohaupt@iof.fraunhofer.de](mailto:matthias.mohaupt@iof.fraunhofer.de)

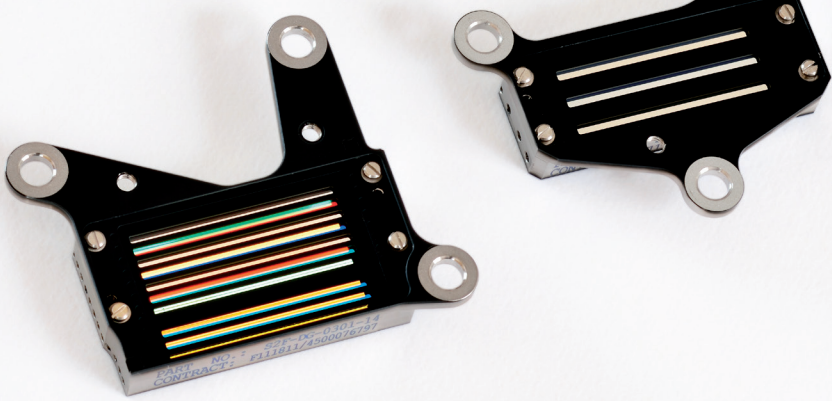

2 *Sentinel 2 VNIR and SWIR filter arrays, integration of single filter stripes into a mechanical mount (developed and manufactured with the financial assistance of the EU and ESA).*

## ADHESIVE BONDING

Adhesive bonding is a well-known process used to fix components of different material combinations. Various integration tasks of optical and mechanical systems can be addressed with the choice of the Young's Modulus, the shrinkage, and the refractive index of the bonding agent. Fraunhofer IOF has experience of adhesive bonding applications and dispensing of glues with different viscosities.

- Adhesive bonding of optics, electronics and mechanics with matching of refractive index and low shrinkage during curing
- FEM simulation of bonding according to customer specifications
- Application of structural, optical and electrically- and thermally conductive bonding
- Space qualified processes (low outgassing rates, total/relative mass loss)
- Bonding applications from prototypes to serial production
- Different types of adhesives – two component epoxies, UV-curable adhesives

---

**Contact | Matthias Mohaupt**

Phone: +49 3641 807 342 | [matthias.mohaupt@iof.fraunhofer.de](mailto:matthias.mohaupt@iof.fraunhofer.de)

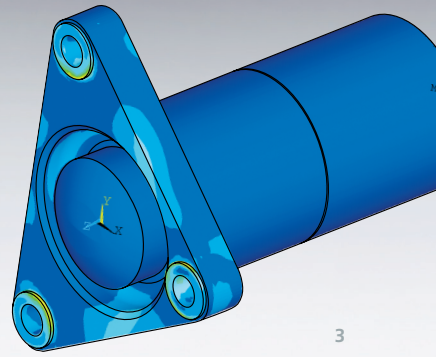
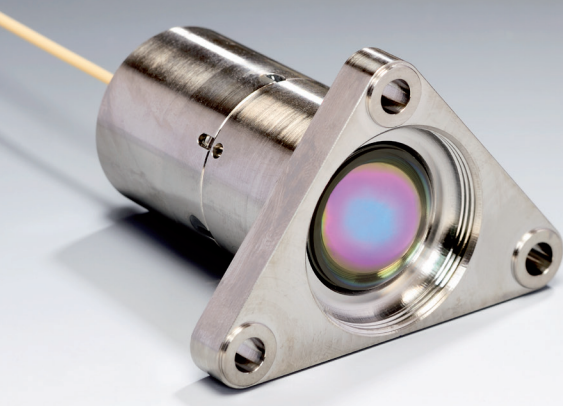

3

## LASER-BASED SPLICING

Laser-based splicing and tapering overcome typical limitations of conventional splice/taper equipment. The technology is contamination-free and suitable for bonding optical components with low difference in thermal expansion. A symmetrical application of CO<sub>2</sub>-laser radiation allows the processing of large geometries.

- Customized system design adapted to our CO<sub>2</sub>-laser splicing technology
- Investigation of thermal, mechanical, and optical stability under harsh conditions in space by Finite-Element-Method
- Packaging/assembly of the spliced components
- Constant measurements of beam quality, wave front error, beam alignment in reference to the mechanical mount for the spliced components during the assembly processes
- Assembly technology for high-power fiber lasers and fiber optics

3 CO<sub>2</sub> laser spliced Fiber Collimator with outstanding performance for an inter-satellite Laser Interferometer (GRACE-FO, a joint US-German mission).

Project partner:  
SpaceTech GmbH

---

Contact | Steffen Böhme

Phone +49 3641 807 305 | [steffen.boehme@iof.fraunhofer.de](mailto:steffen.boehme@iof.fraunhofer.de)



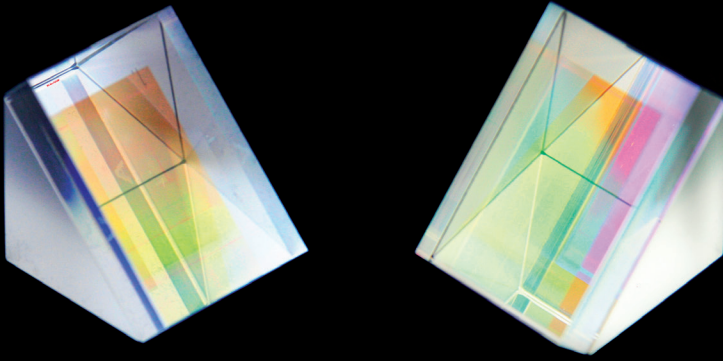

4

## INTERLAYER-FREE BONDING

### 4 GRISM

Interlayer-free bonding offers advantages compared to conventional joining technologies. It allows bonding optical components with the same composition without changing the index of refraction. The minimized absorption in the transition zone leads to assemblies for high-power applications with reduced thermal lensing and reduced stress in optical materials. Fraunhofer IOF develops high accuracy joining of different materials for optical systems, e.g. fused silica, sapphire and optical crystals.

- Interlayer-free joining of single crystalline laser materials, e.g. for transmissive applications at high laser power (Faraday isolators, second harmonic generation components)
- Joining of optical components with high positioning accuracy, e.g. prism-to-grating bonds (GRISM)  
Encapsulation of gratings capable of withstanding high laser power densities
- Verified high bonding strength, at least half of bulk strength

---

**Contact | Carolin Rothhardt**

Phone +49 3641 807 304 | [carolin.rothhardt@iof.fraunhofer.de](mailto:carolin.rothhardt@iof.fraunhofer.de)

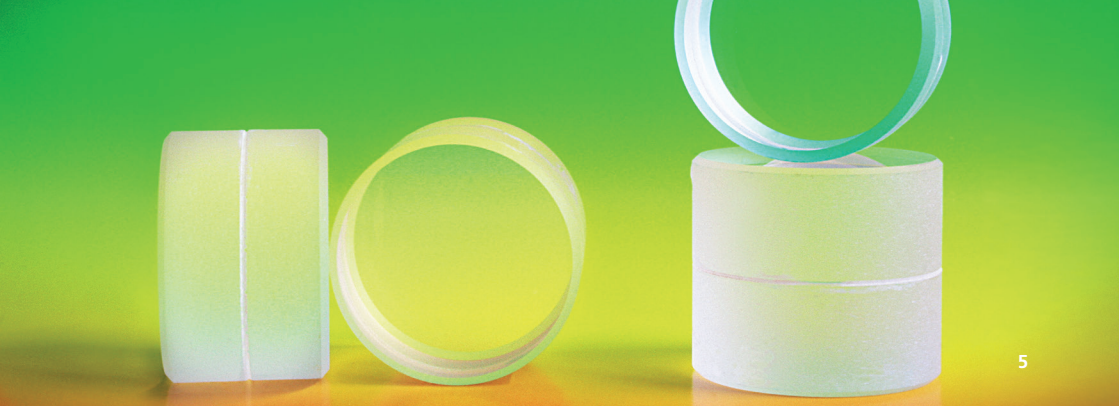

## SILICATE BONDING

Silicate Bonding forms a materials-adapted bond connection between glasses and glass-ceramics without polymers. This induces less stress at elevated temperatures for low-expansion materials. It allows to fill gaps in the micron range which is favorable for joining conform surfaces. We offer high accuracy joining with creep- and drift-free bonds.

*5 Silicate bonded glass (BK7, fused silica) and glass-ceramics, diameter 25 mm.*

- Transparent bonding for optical and structural applications
- Verified bond strength in the range of 50% of the bulk material
- Bond connection withstands subsequent processing steps, e.g. polishing
- Joining of conform surfaces with gaps in the micron range, e.g. convex-concave surfaces for mirror bodies or planar surfaces

---

**Contact | Carolin Rothhardt**

Phone +49 3641 807 304 | [carolin.rothhardt@iof.fraunhofer.de](mailto:carolin.rothhardt@iof.fraunhofer.de)

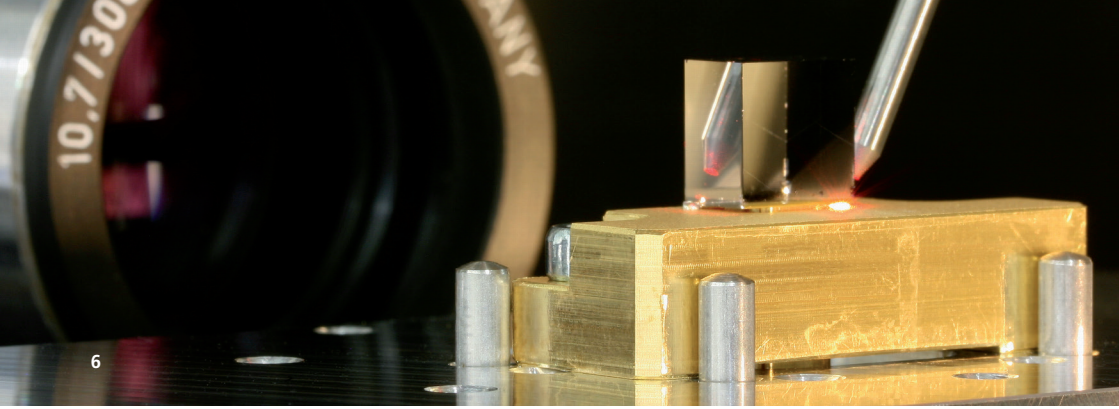

6

## LASER-BASED SOLDERING

6 *Soldering of optical components to mounts.*

Laser-based soldering is an innovative process for the high accuracy joining of optical components to complex, multifunctional and hybrid assemblies. The Fraunhofer IOF uses different flux-free soldering processes for miniaturized photonic systems with improved mechanical properties. They are suitable for vacuum conditions and harsh load cases. The contact-free laser-based input of reflow energy minimizes the thermal load during assembly and allows high accuracy bonds.

- Solderjet Bumping for complex 3D components with sub-micron accuracy
- Thin-film and preform based soldering for planar components
- Flux-free joining of heterogenous materials
- High positional accuracy and long term stability
- Customized selection of solder alloys
- Packaging technique for high-power lasers, micro- and macro-optical systems

---

**Contact | Thomas Burkhardt**

Phone +49 3641 807 339 | [thomas.burkhardt@iof.fraunhofer.de](mailto:thomas.burkhardt@iof.fraunhofer.de)

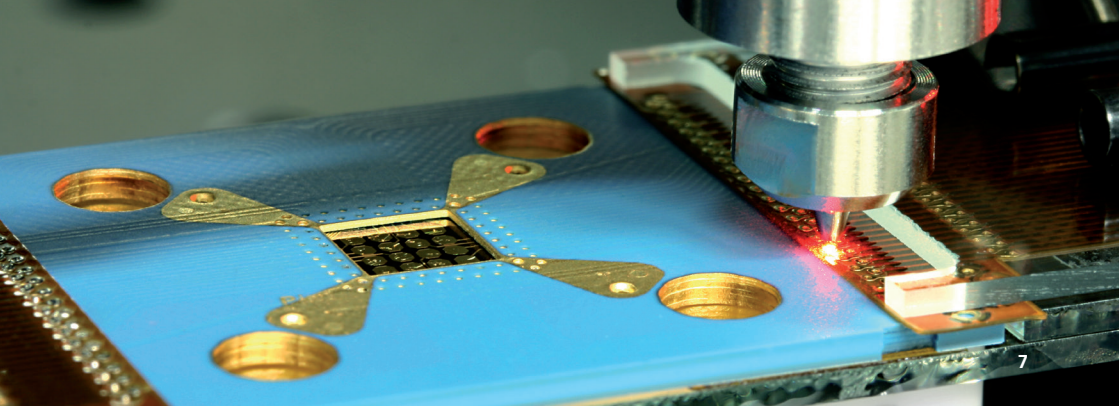

## SYSTEM INTEGRATION

Fraunhofer IOF develops integration approaches based on multifunctional system platforms made of ceramics or glass-ceramics. These provide a stable base for the mounting of optical components and maintain the high performance while reducing the cost of complex opto-electro-mechanical systems. IOF's ultra-precise production technologies along with advanced tactile and optical metrology provide high quality mechanical stops and references for efficient and simple alignment.

*7 Hybrid integration using multi-layered ceramic platform.*

- New concepts for system integration of hybrid micro- and macro-optical systems
- Ultra-precision machining based on diamond turning for reference surfaces and mechanical stops
- Ultrashort pulse lasers for structuring and drilling
- Surface conditioning and functionalization
- Precise and reproducible alignment with sub-micron accuracy

---

**Contact | Dr. Erik Beckert**

Phone +49 3641 807 338 | [erik.beckert@iof.fraunhofer.de](mailto:erik.beckert@iof.fraunhofer.de)

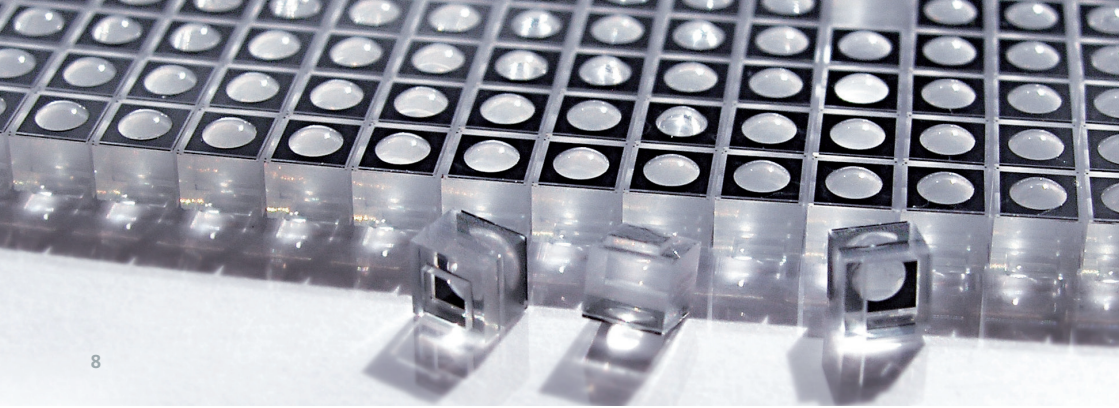

8

## WAFER-LEVEL OPTICS

8 *Miniaturized camera optics after dicing.*

Lithography based techniques not only enable the generation of optical micro- and nano-structures but also the hybrid integration of complex systems by stacking of several functional layers. Structured layers are aligned and transferred to the substrate with the use of a mask aligner along with further processes. A number of systems are typically generated in parallel on a wafer and are separated at the end.

- For illumination, beam shaping, sensors and display applications
- Refractive, diffractive and hybrid optical micro- and nano-structures in glass or polymer on glass
- Integration of apertures, reflectors or other coatings patterned by lithography
- Patterning by photo- and electron-beam-lithography, wet and dry etching, lift-off, UV polymer replication
- On wafers  $\varnothing$  75 mm to  $\varnothing$  200 mm + non-standard sizes
- Backside patterning and stacking of structural layers
- Integration of spacer patterns and stacking of wafers
- Wafer scale integration with optoelectronics

---

**Contact | Dr. Peter Dannberg**

Phone +49 3641 807 420 | [peter.dannberg@iof.fraunhofer.de](mailto:peter.dannberg@iof.fraunhofer.de)

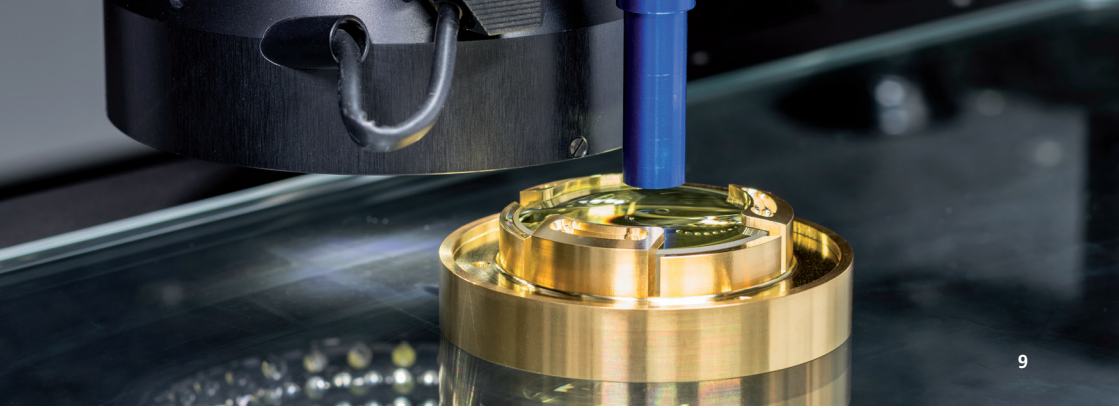

## MEASUREMENT AND CHARACTERIZATION

Fraunhofer IOF offers comprehensive optical and mechanical characterization equipment to test and analyze optical components and systems at all stages of the assembly process. System tests include long term, thermal cycling and various mechanical load scenarios tailored to customer specifications..

*9 Optical metrology of a mounted optical component.*

- Polarimetric measurement of stress birefringence in optical elements
- Tracking of adjustment status using non-contact optical measurement equipment  
e.g. autocollimator and white light sensors
- Interferometrical measurement of long term stability and surface deviation
- Compression/Tension/Shear testing for determination of mechanical strength of bonded components
- X-ray micro tomography for non-destructive inspection and three-dimensional measurements of joints and assemblies

---

**Contact | Dr. Erik Beckert**

Phone +49 3641 807 338 | [erik.beckert@iof.fraunhofer.de](mailto:erik.beckert@iof.fraunhofer.de)



## CONTACT

### Address

Fraunhofer Institute for Applied Optics and  
Precision Engineering IOF  
Albert-Einstein-Str. 7, 07745 Jena, Germany  
[www.iof.fraunhofer.com](http://www.iof.fraunhofer.com)

### Director

Prof. Dr. Andreas Tünnermann  
Phone +49 3641 807 201  
[andreas.tuennermann@iof.fraunhofer.de](mailto:andreas.tuennermann@iof.fraunhofer.de)

### Contact persons

Dr. Ramona Eberhardt  
Phone +49 3641 807 312  
[ramona.eberhardt@iof.fraunhofer.de](mailto:ramona.eberhardt@iof.fraunhofer.de)

Dr. Erik Beckert  
Phone +49 3641 807 338  
[erik.beckert@iof.fraunhofer.de](mailto:erik.beckert@iof.fraunhofer.de)



[IOF.FRAUNHOFER.COM](http://IOF.FRAUNHOFER.COM)